

## Situação Atual Guarita Ed. Ruy Barbosa

PROC. 23.005386-6

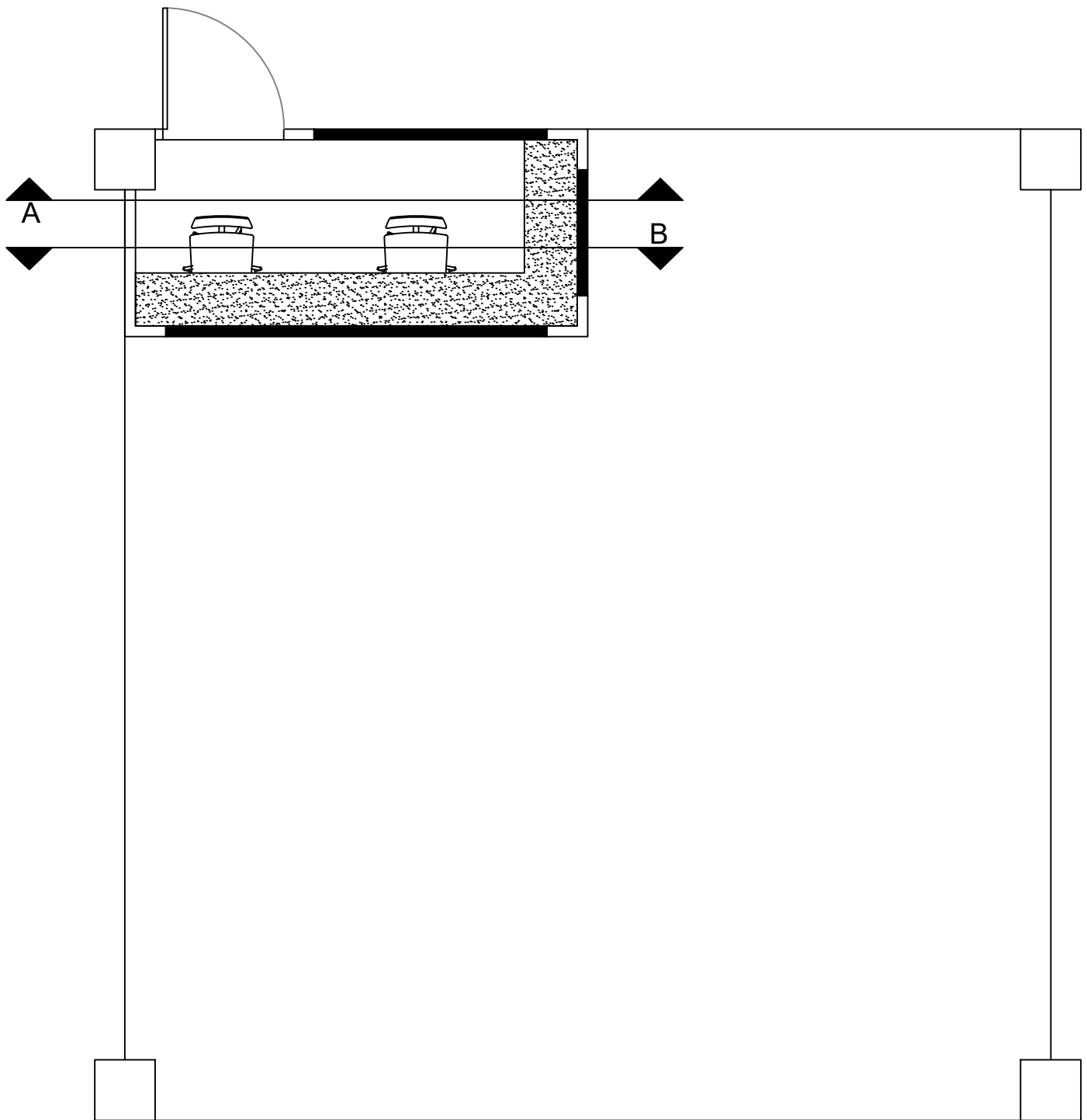

Planta baixa  
Edf. Ruy Barbosa

PROC. 23.005386-6

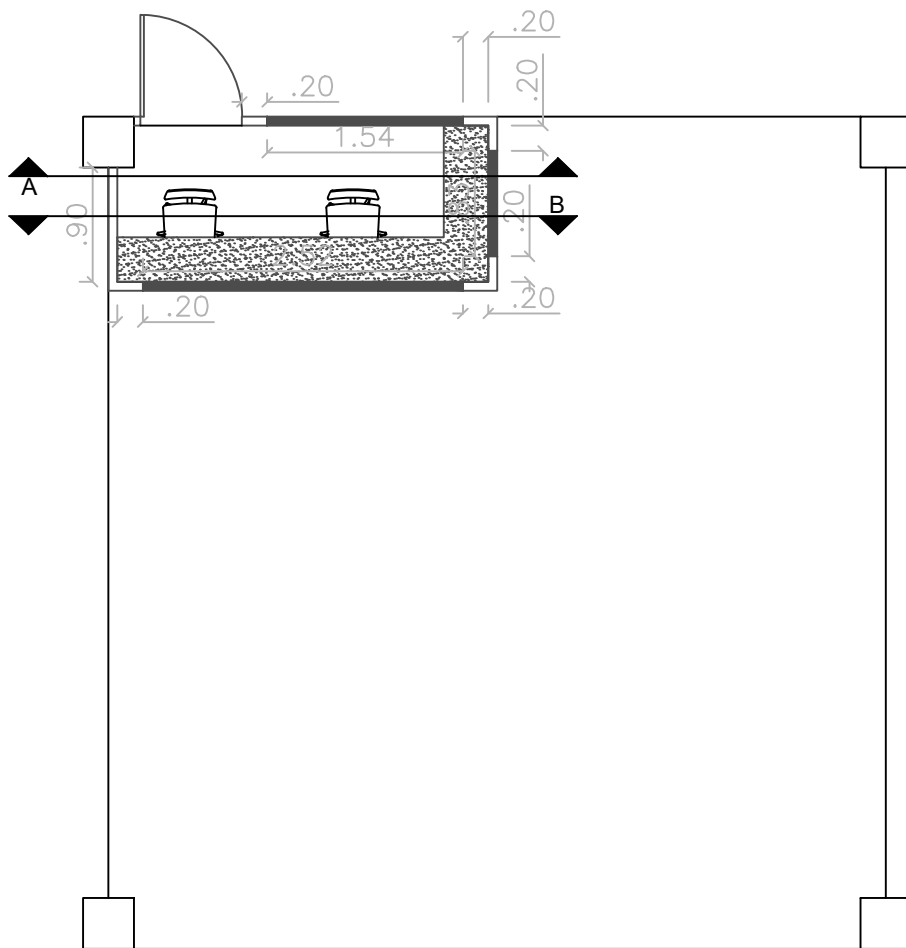

## Planta de construção Edf. Ruy Barbosa

PROC. 23.005386-6

 a construir

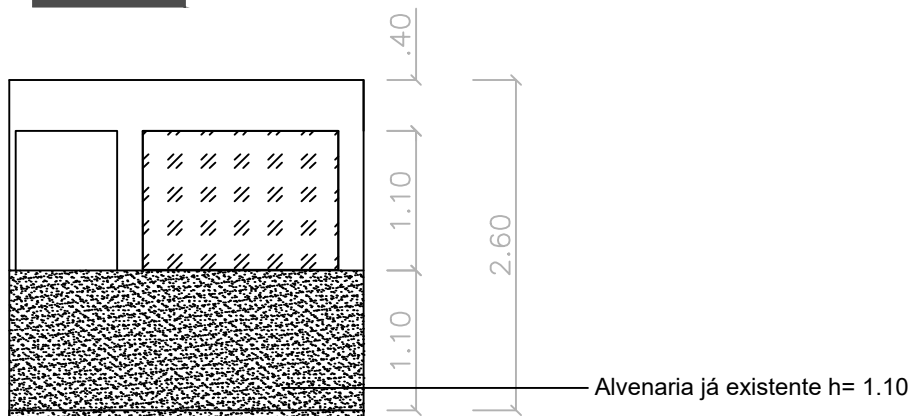

Corte esquemático AA

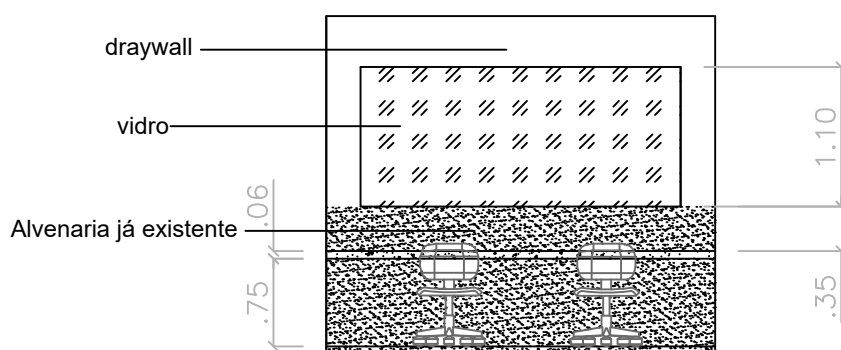

Corte esquemático BB

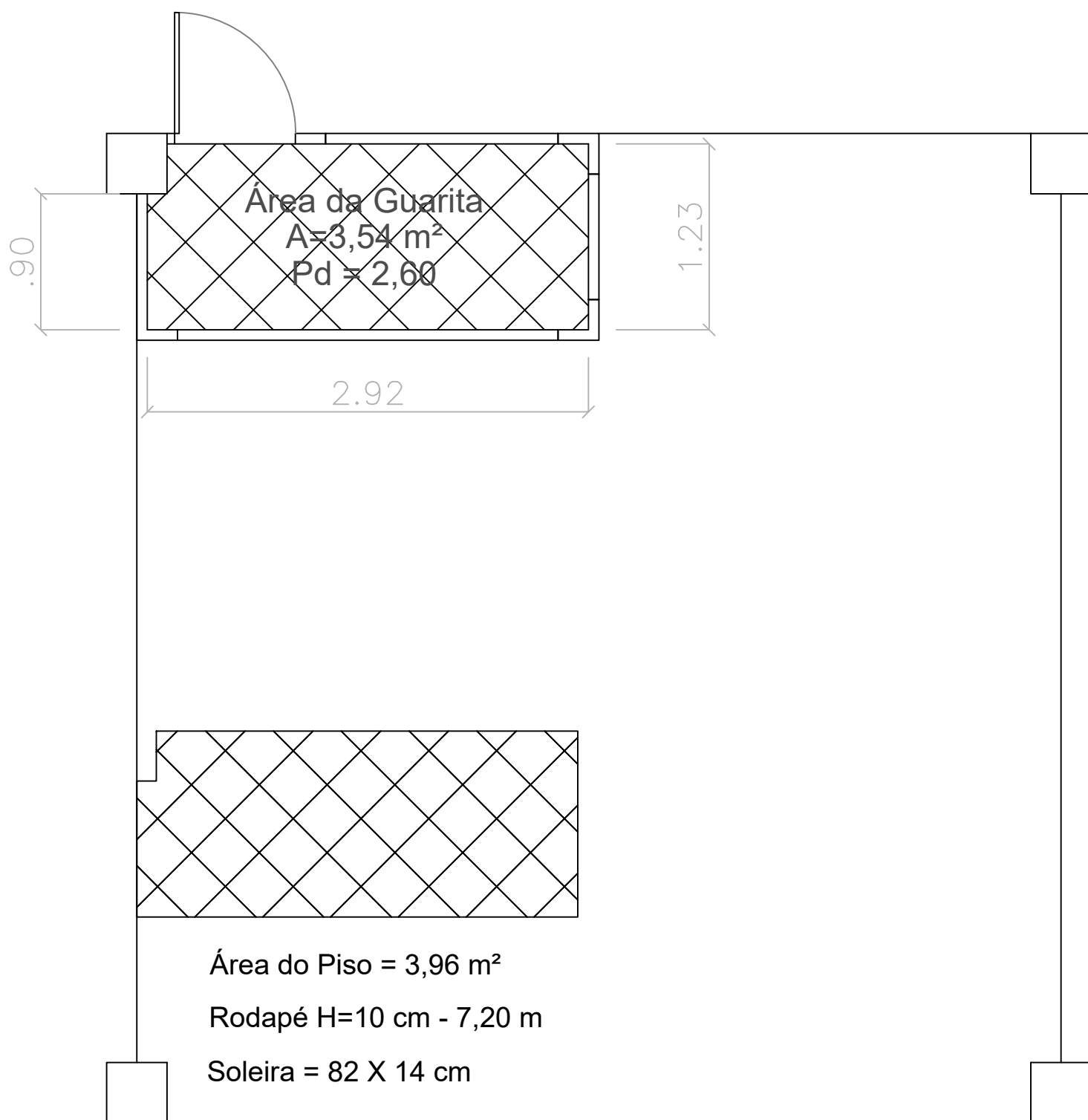

## Sugestão de Implantação

### Edf. Ruy Barbosa

PROC. 23.005386-6

Sugestão de  
instalação de  
bebedouro

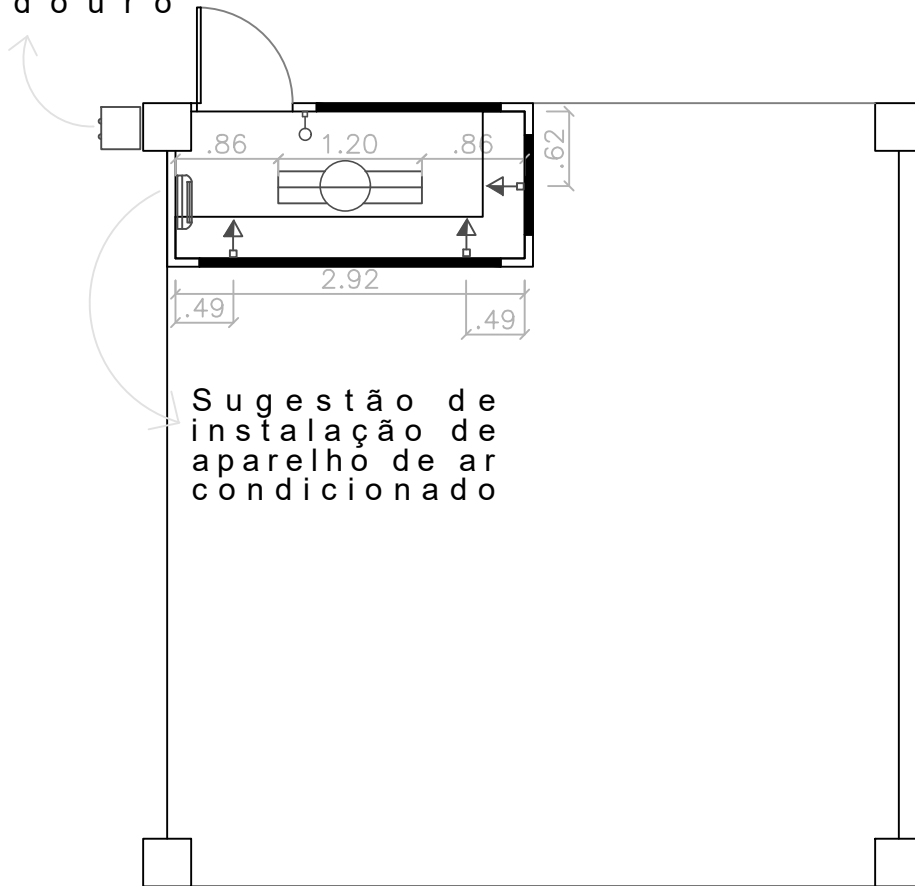

## Implantação de tomadas e luminárias Edf. Ruy Barbosa

PROC. 23.005386-6

### Legenda



Interruptor simples 1 tecla - 1,10m do piso



Tomada hexagonal (NBR 14136) - 2P+T 10 A a 1,10m do piso

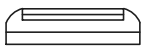

Aparelho de ar condicionado

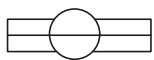

Luminárias de embutir Led 2x20W 1.20 X 0.27



Bebedouro

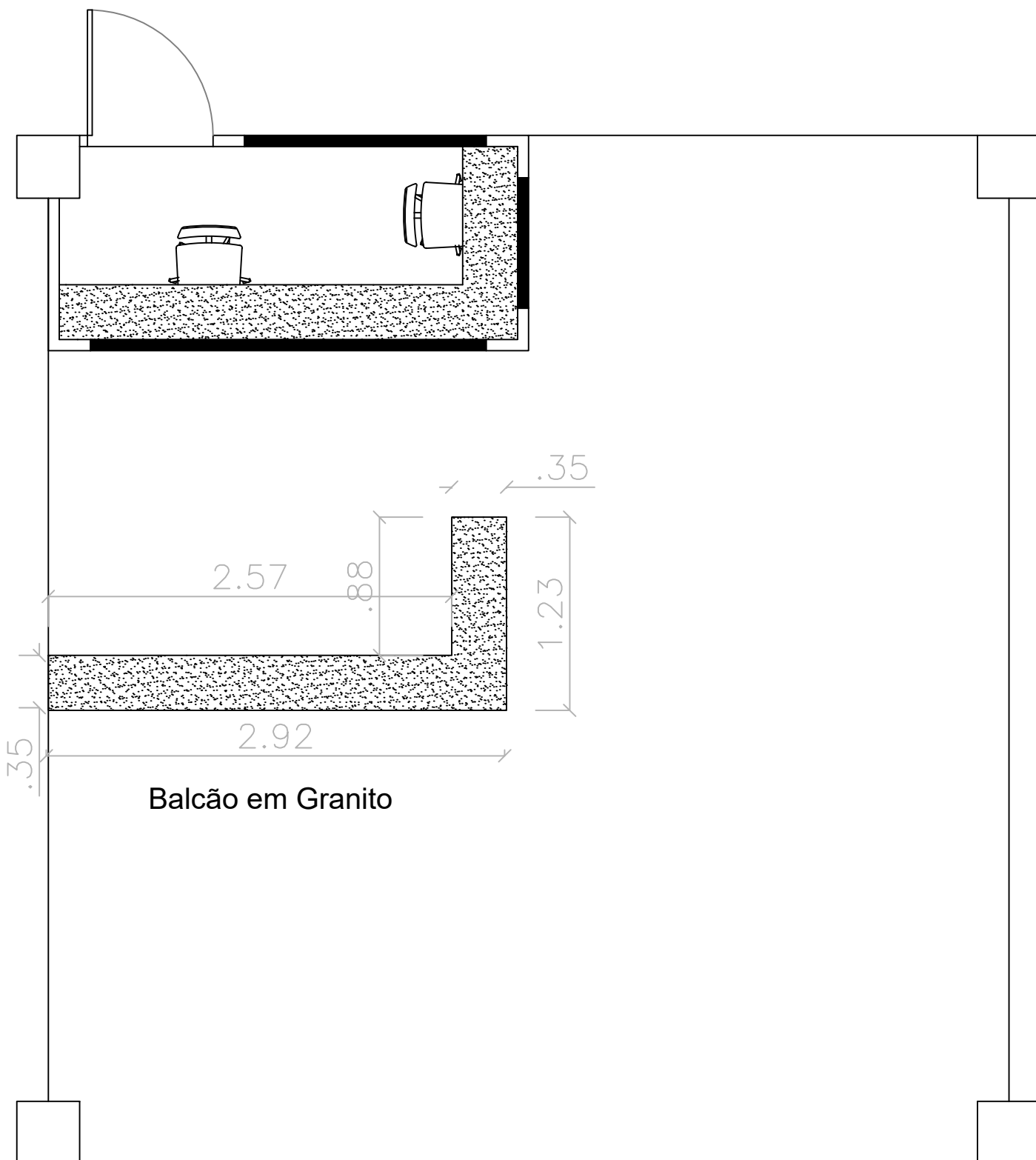

# Detalhe balcão

## Edf. Ruy Barbosa

PROC. 23.005386-6

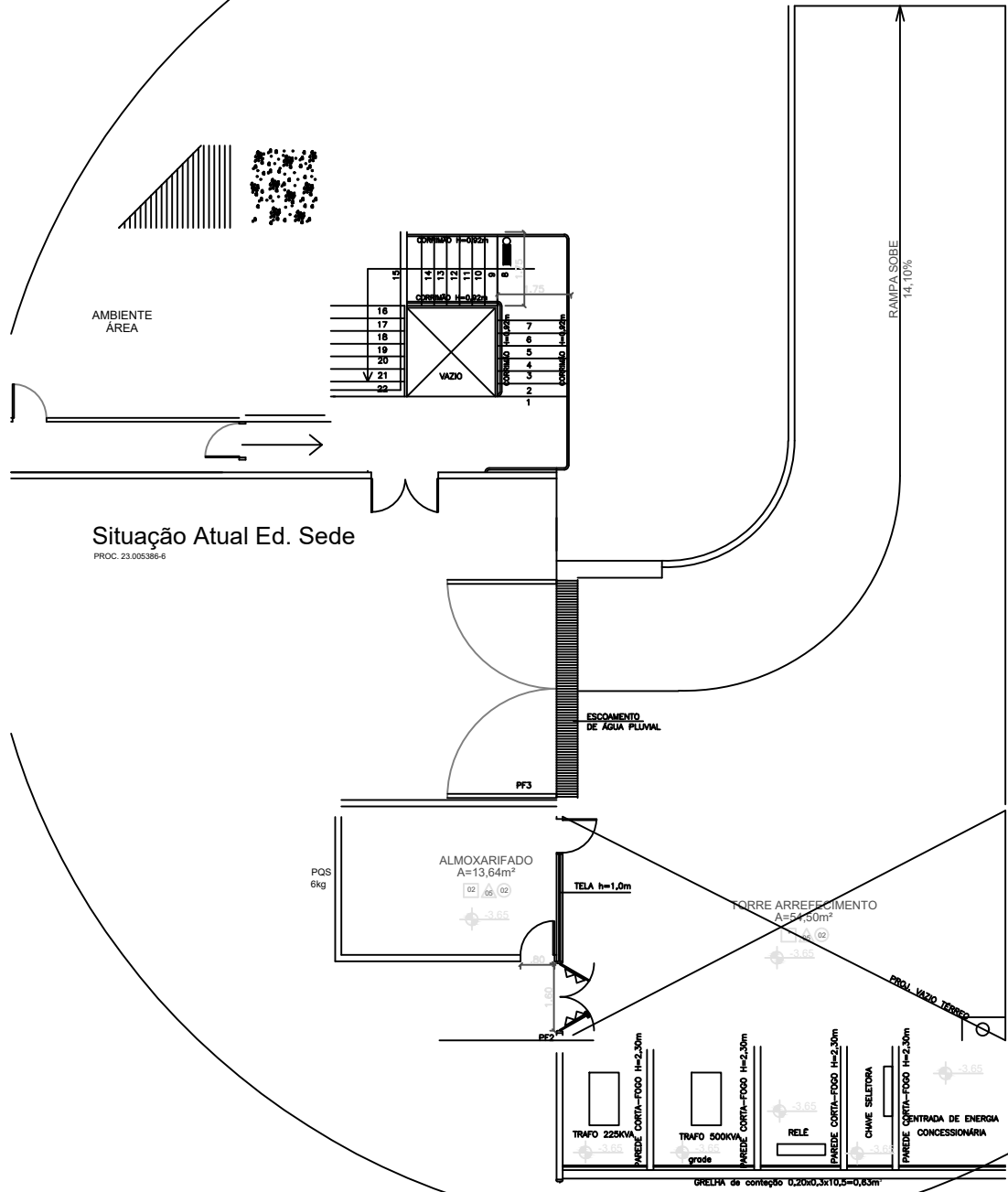

Situação Atual Ed. Sede

PROC. 23.005386-6

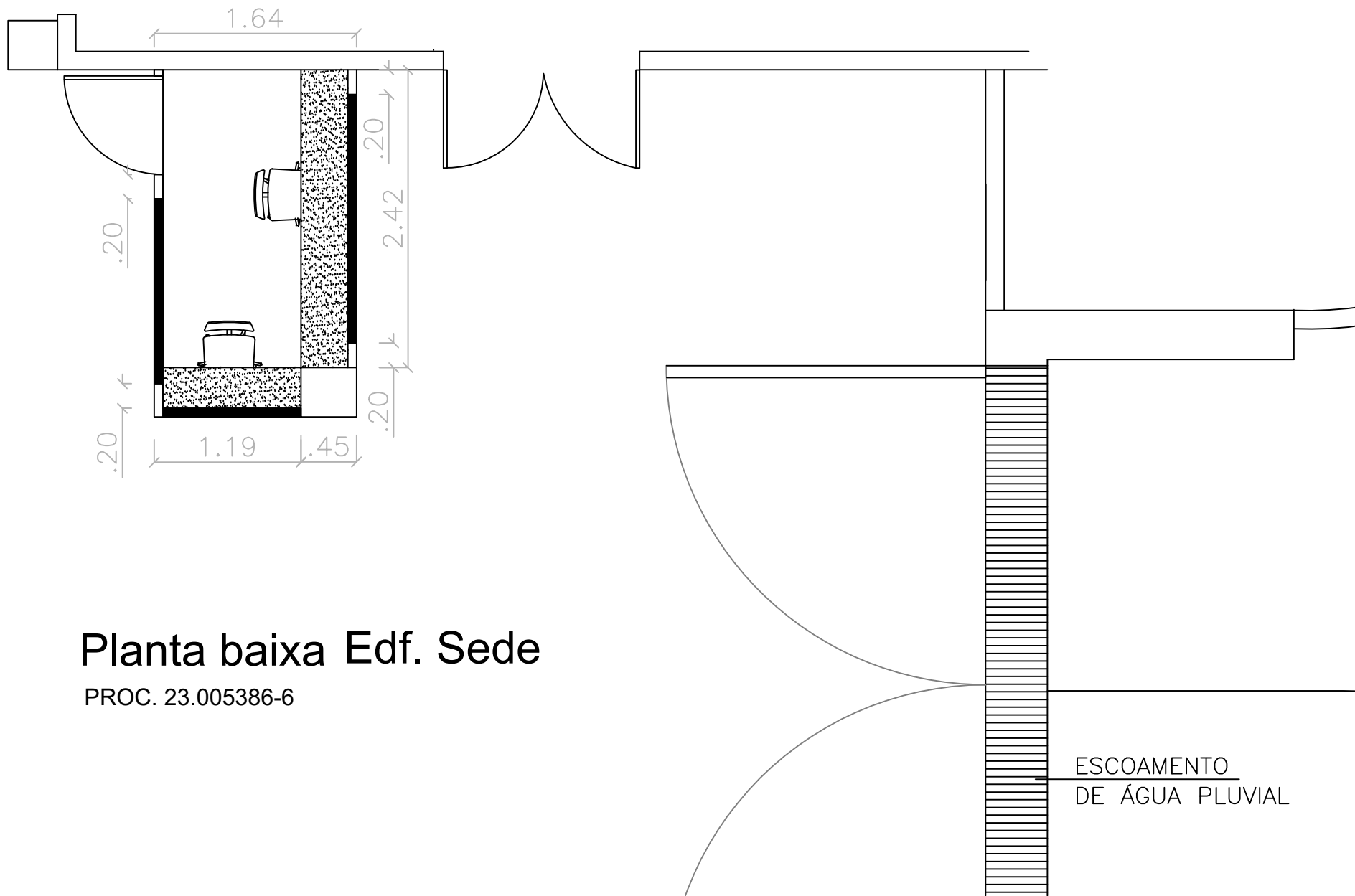

# Planta baixa Edf. Sede

PROC. 23.005386-6

ESCOAMENTO  
DE ÁGUA PLUVIAL



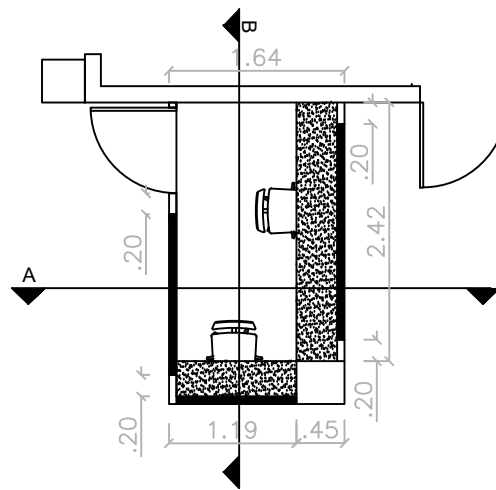

Situação Proposta da Guarita Ed. Sede  
 PROC. 23.005386-6

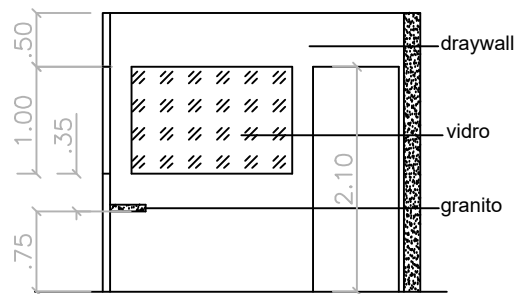
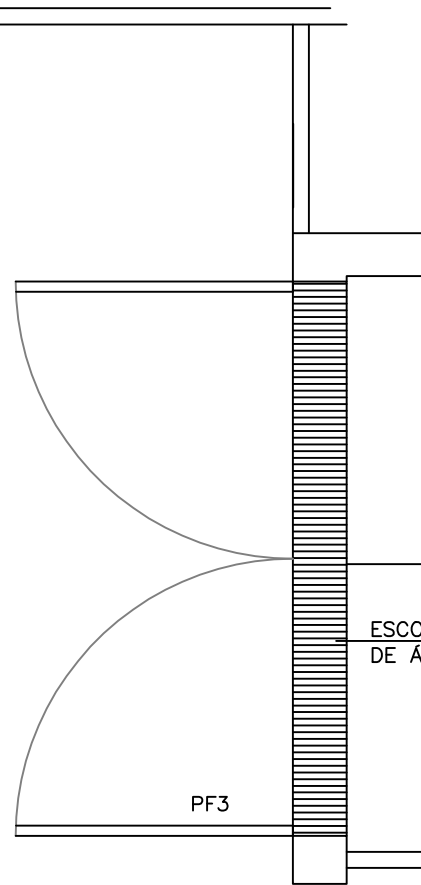

Corte esquemático AA

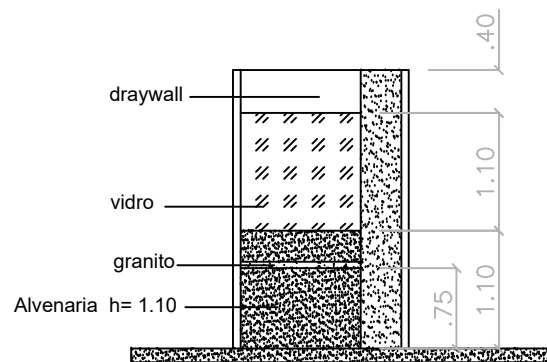

Corte esquemático BB

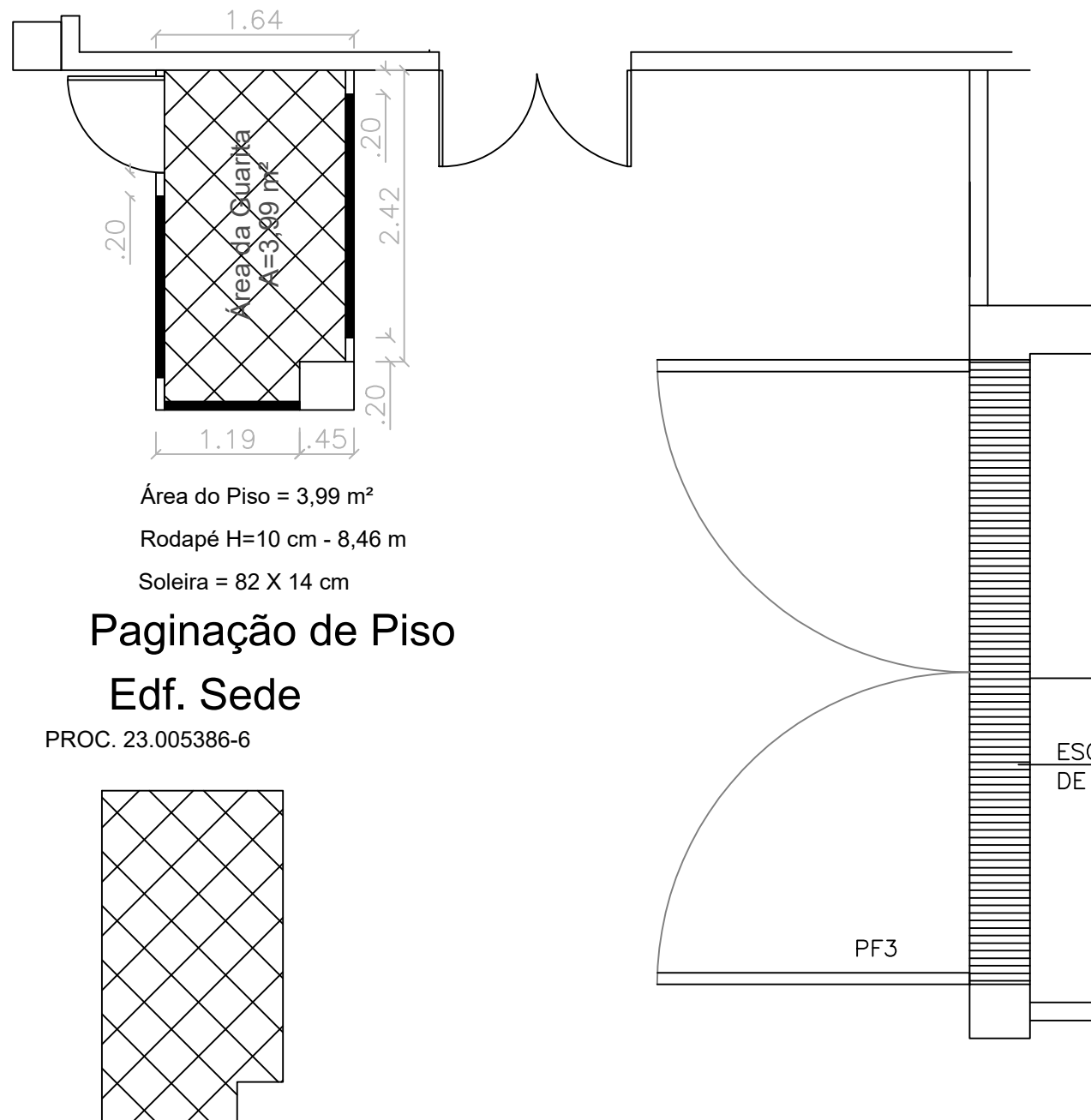

Área do Piso = 3,99 m<sup>2</sup>

Rodapé H=10 cm - 8,46 m



Soleira = 82 X 14 cm

## Paginação de Piso

### Edf. Sede

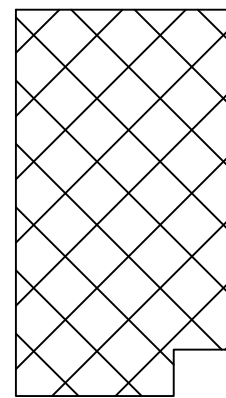
PROC. 23.005386-6

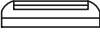
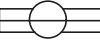

Legenda	
	Interruptor simples 1 tecla - 1,10m do piso
	Tomada hexagonal (NBR 14136) - 2P+T 10 A a 1,10m do piso
	Aparelho de ar condicionado
	Luminárias de embutir Led 2x20W 1.20 X 0.27

